

1. Find the measure of  $\angle P$  to the nearest degree.

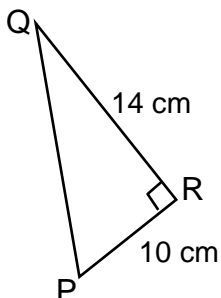

2. Find the length of TU to the nearest tenth of a centimeter.

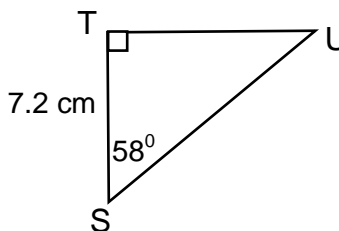

3. A flagpole casts a shadow that is 25 m long when the angle between the sun's rays and the ground is  $40^\circ$ . What is the length of the flagpole to the nearest meter?

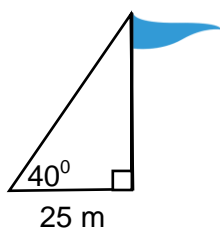

4. Use the information in the diagram to find the height of the tower of the wind turbine. Give the answer to the nearest tenth of a meter.

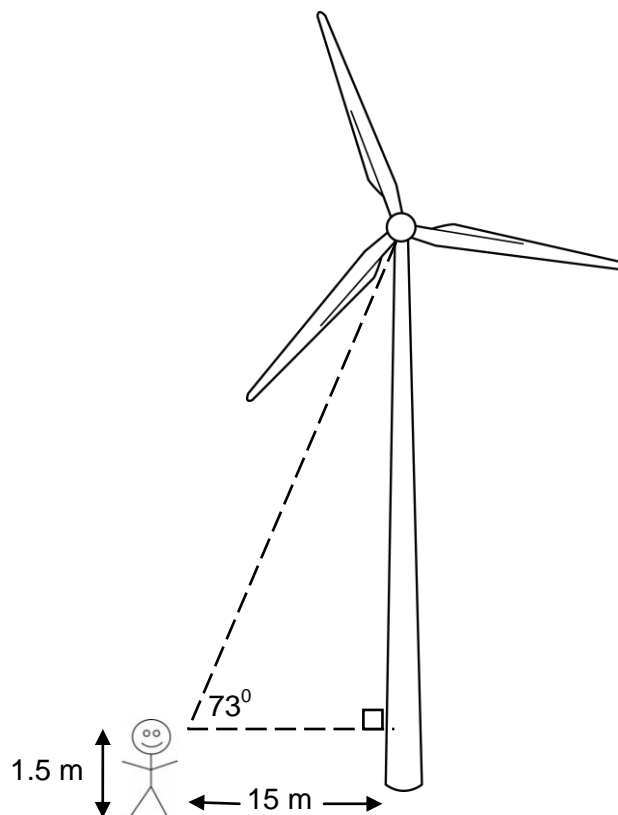

5. Find the measure of each indicated angle to the nearest degree.

a)

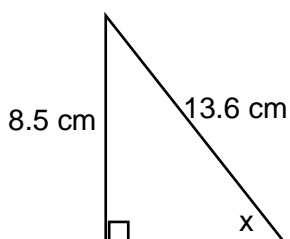

b)

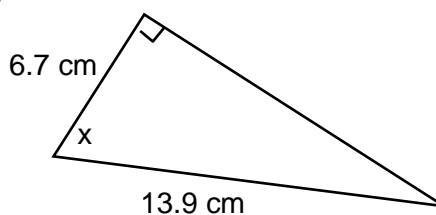

6. A 2.8m ladder is leaning against a barn. What angle does the ladder make with the barn, to the nearest degree?



7. Find the length of each indicated side to the nearest tenth of a centimeter.

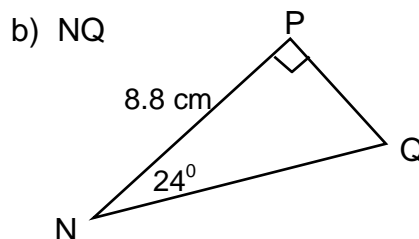
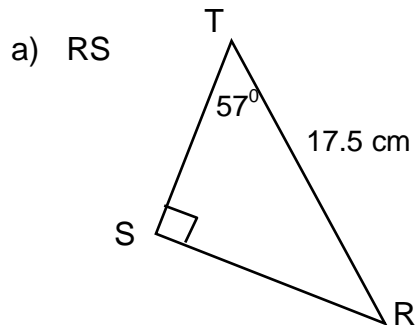

8. An escalator is 14.5m long. The escalator makes an angle of  $27^\circ$  with the ground. What is the height of the escalator to the nearest tenth of a meter?

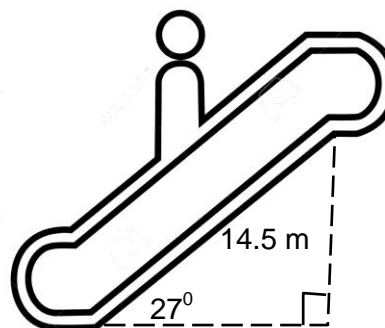

9. Solve the triangle. Give side lengths to the nearest tenth and angles to the nearest degree.

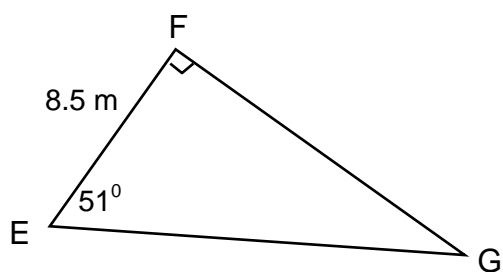

10. Two buildings are 25 m apart. From the top of the shorter building, the angles of elevation and depression of the top and bottom of the taller building are  $31^\circ$  and  $48^\circ$  respectively. What is the height of the taller building? Give your answer to the nearest meter.

